

Submerged Microfiltration Membrane Bioreactor (MBR) Module

	HYDRAsub [®] - MBR	HSM1000-ES
Module Specifications	Configuration: Fiber Orientation: Filtrate Flow : Membrane Polymer: Pore Size (nominal): Number of Elements in Module: Nominal Membrane Area per Module: Permeate Connections: Air Connections: Guide Pipe Connections: Typical Module Dry Weight: Typical Module Wet Weight:	Submerged Membrane Vertical Bi-directional Polyvinylidene Flouride (PVDF) 0.4 µm 40 (25 m ² each) 10760 ft ² (1000 m ²) (2)- 3" MNPT (2)- 3" MNPT (2)- To fit 3" pipe 2682 lbs (1216 kg) 4226 lbs (1916 kg)
Operating Specifications	Maximum Transmembrane Pressure (Vacuum): Maximum Backwash Pressure : Maximum Instantaneous Chlorine Concentration: Maximum Chlorine Tolerance: MLSS Range: Operating Temperature Range: Feed Water pH Range: Cleaning pH Range: Operating Mode:	-6 psig (-0.41 bar) 2 psig (0.14 bar) 5,000 ppm ^a 742,000 ppm-hrs ^b 8,000 - 12,000 mg/L ^c 41 - 104°F (5 - 40° C) 6.0 - 8.0 1.0 - 11.0 Outside to Inside
Typical Process Conditions	Operating Filtrate Flux [†] : Peak Operating Flux [†] : Chemically Enhanced Backwash (CEB) Flux: CEB Chemicals: Clean In Place (CIP) Flux: CIP Chemicals:	4-20 gfd (7-34 l/mh) 30 gfd (51 l/mh) 2.4 gfd (4 l/mh) NaOCl ^d 2.4 gfd (4 l/mh) NaOCl or Citric Acid ^d

† -Depends on temperature and application

a -For a maximum of 2 hours

b- Maximum chemical tolerance for estimated life span of membrane

c -In membrane tank at steady state for municipal wastewater

d- Refer to operating manual for chemical concentrations and cleaning frequencies

Hydranautics believes that the information and data contained herein to be accurate and useful. The information and data are offered in good faith, but without guarantee, as conditions and methods of use of our products are beyond our control. Hydranautics assumes no liability for results obtained or damages incurred through the application of the presented information and data. It is the user's responsibility to determine the appropriateness of Hydranautics' products for the user's specific end uses.

HSM1000-ES

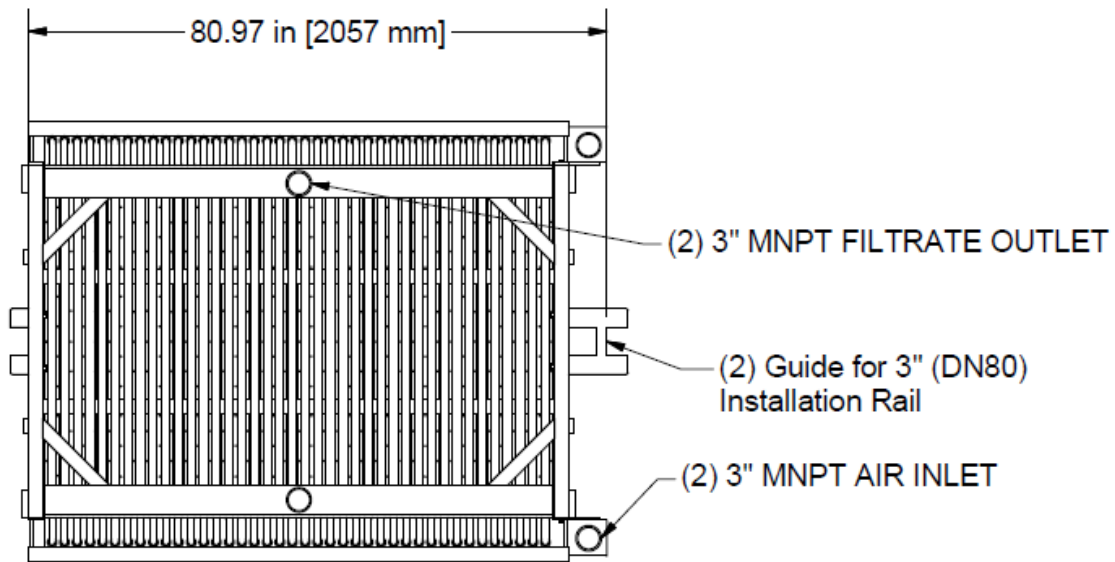

Top View

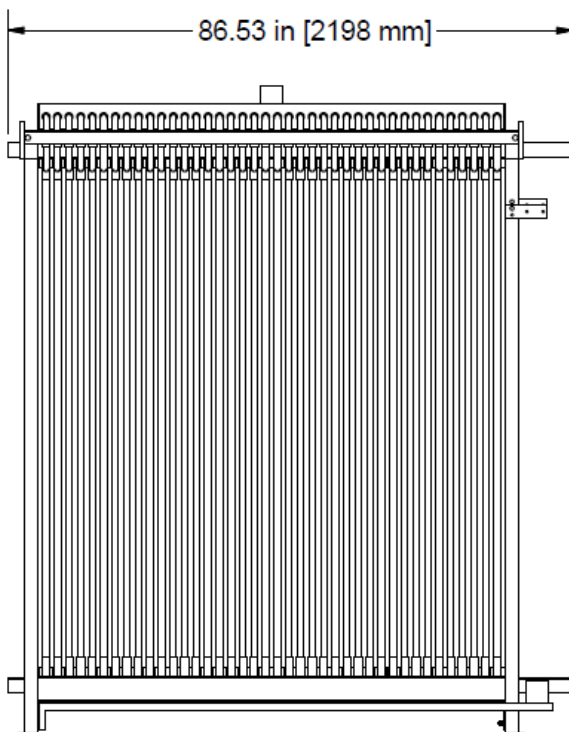

Side View

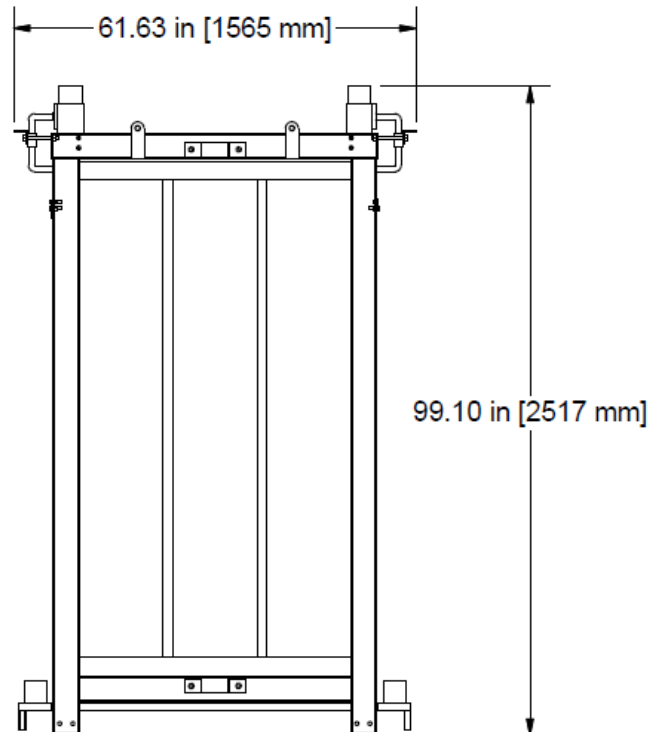

Front View

Note: Cage is made of stainless steel 304. Connections are in English units. For more detailed drawings, contact Hydranautics.

11/18/13