

Ft. Lauderdale 12-MGD Water Treatment Plant: Double Hybrid RO and NF Design

Authors:

Kirk Lai Hydranautics Field Service Engineer Buda, TX.
Wayne Bates Hydranautics Technology Department Staff Engineer Rockton, IL.
Dr. Craig Bartels Hydranautics Technology Department Vice President Oceanside, CA.

**AWWA 10th Biennial Membrane Technology Conference & Exposition
Memphis, Tn. March 15-18, 2009**

Introduction

The City of Ft. Lauderdale Peele-Dixie Water Treatment Plant is a 12 MGD (1,893 M³/day) facility with four membrane system trains producing 3 MGD (473 M³/day) capacity per train. This plant required a significant review of the optimal dosing of sulfuric acid in lowering feed pH and the use of antiscalant to control the precipitation of hardness while maintaining sufficient levels of alkalinity to meet permeate quality goals and chemical costs. The plant used a low TDS well water supply from the Biscayne Aquifer ranging from 350 to 500 ppm, feed iron up to 2 ppm, total hardness up to 270 ppm as CaCO₃, alkalinity before acidification up to 270 ppm as CaCO₃, TOC as high as 11 ppm, and color as high as 90 Color Units.

This plant was successfully started and commissioned between April and July 2008. The permeate quality goals of this potable water treatment facility were very stringent and required extensive pilot testing to develop an optimal spiral wound membrane design configuration using both RO (reverse osmosis) and NF (nanofilter) membranes. The water quality objectives of the plant were to produce a permeate with a maximum iron level of 0.15 ppm, a maximum hardness level of 30 ppm as CaCO₃, a maximum TOC of 1.0 ppm, color less than 3 Color Units, while providing a sufficiently high passage of bicarbonate ion to produce a minimum alkalinity level of 10 to 15 ppm as CaCO₃. A minimum level of permeate alkalinity was desired to make the finished water less corrosive in the city's distribution piping.

The system configuration by train is a 53 pressure vessel 1st stage by 24 pressure vessel 2nd stage pyramidal two-stage array with seven element long pressure vessels. The design incorporated the use of seven ultra-low pressure RO membrane elements per pressure vessel in the 1st stage. This is followed by a 2nd stage containing 4 ultra-low pressure RO membrane elements and then 3 high-flow/low-rejection NF membrane elements in the same pressure vessel.

This unique design, referred to as a Double Hybrid RO/NF design, produced the client's required stringent permeate water quality at a very low operating pressure of about 100 psi. Pilot testing was required to develop and confirm a design basis and rejection criteria for each type of RO and NF membrane employed. The position of each RO and NF membrane in the system has an impact on the specific water quality that the train can produce. The design used for this plant would be a model for future designs that required balancing of permeate water quality while optimizing energy requirements. One such example is nearby Pompano Beach.

Ft. Lauderdale Membrane Plant Design Considerations

Design work for this membrane plant renovation started in 2003 under the City of Ft. Lauderdale's "Waterworks 2011" \$550 million dollar infrastructure project which also included sanitary sewer, water main replacement, force-mains, and well-field expansions. All renovations are planned to be completed by 2011, in time for the City's 100 year anniversary.

The feed water source is the Biscayne aquifer. This aquifer is located strictly in South Florida in parts of Dade, Broward and Palm Beach Counties. This aquifer underlies an area of approximately 4,000 square miles and is a highly permeable aquifer and consists mainly of limestone and less-permeable sandstone and sand. The water from the Biscayne aquifer has relatively high calcium and magnesium hardness and low sodium and chloride levels. The TDS (total dissolved solids) from the Biscayne aquifer is typically between 400 to 800 ppm and at this site about 350 to 500 ppm TDS which does result in lower osmotic pressure requirements and therefore lower feed pressure requirements. A drawback to the use of Biscayne water, and therefore a challenge in designing the system, is the relatively higher levels of iron foulant and higher levels of organic matter foulant compared to other possible feed water sources. The benefit of using Biscayne water is the lower feed pressure requirements for the system operation and therefore a more cost effective water source in terms of electrical energy requirements and costs. The development of reduced fouling NF membranes has also made the operation of producing potable water from the Biscayne aquifer very cost effective. In some instances ultra-low pressure RO membranes in conjunction with low-fouling NF membranes can produce a viable and cost effective method of meeting State Drinking Water limits for iron and hardness levels simultaneously. ⁽¹⁾

Diagram 1 highlights the major components of the Ft. Lauderdale process design.

Each individual membrane train would be controlled by three control loops. Each skid would have its own RO Feed Pump with VFD controlled motors to control overall permeate production. The 1st stage permeate flow control valve would control 1st stage permeate flux. Overall train recovery would be controlled at 85% by the 2nd stage concentrate flow control valve at each skid.

Raw water feed was to be pretreated by using automatically back-washable 50 to 100 micron nominally rated strainers, 98% sulfuric acid pH adjustment system and/or antiscalant injection system, and 5-micron nominally rated cartridge filters. During raw water system flushing or plant startup, conditioned water can be by-passed to the concentrate disposal system either before or after the cartridge filters. The membrane and the antiscalant are to be NSF-61 approved products.

Permeate from each skid was piped to air strippers in a common header to remove carbon dioxide and VOC (volatile organic contaminants), if present. The static head to the top of the air strippers would maintain a relatively constant back-pressure on the plant permeate header.

Concentrate from each skid was piped to a concentrate booster pump station in a common header. The concentrate pumps can forward the concentrate to an on-site injection well or to an off-site waste-water lift station.

Diagram 1: Ft. Lauderdale Peele-Dixie Plant Process Design

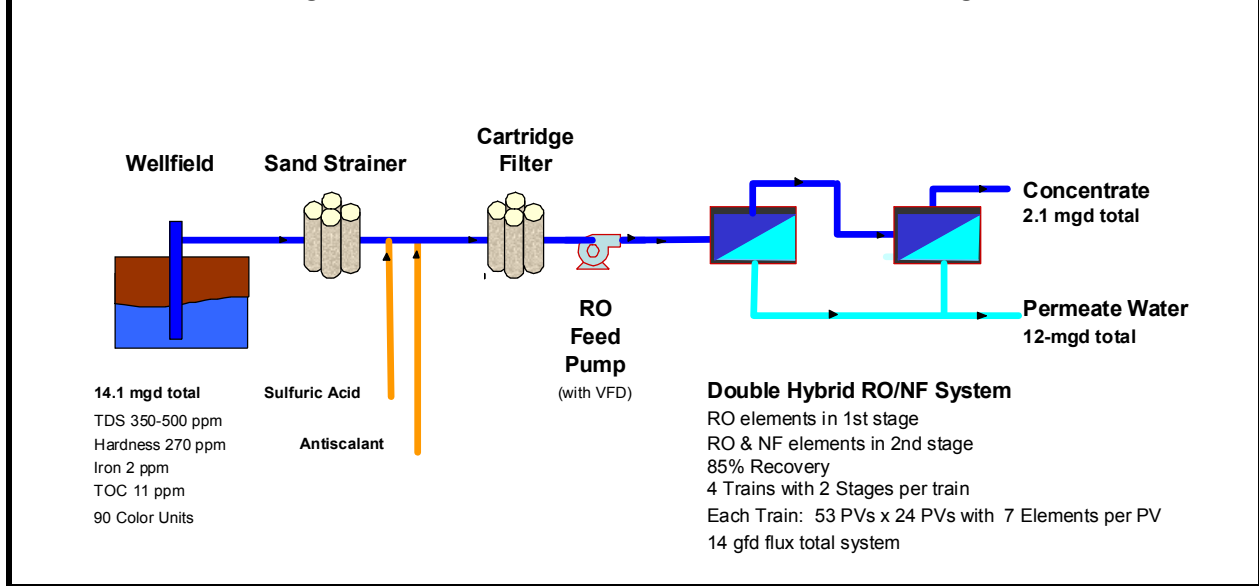

Table 1: Membrane System Design Summary

Permeate capacity (total)	12 MGD	1,893 M ³ /day
Number of Skids	4	
Permeate capacity per skid	3.0 MGD	473 M ³ /day
Permeate flux per skid	< 14.0 gfd	< 23.8 LMH
Recovery (design & maximum)	85%	
Recovery (minimum)	80%	
Number of stages per skid	2	
Number of pressure vessels per skid	77	
Array per skid	53 x 24	
# Membrane elements per pressure vessel	7	
1 st Stage Membrane Type (all seven)	All 7 are RO	
2 nd Stage Membrane Types (lead to tail end)	4 RO, then 3 NF	
1 st Stage permeate flow per skid (design)	2.25 MGD	381 M ³ /day
1 st Stage permeate flux per skid (design)	15.2 GFD	25.8 LMH
2 nd Stage permeate flux per skid (design)	11.2 GFD	19.0 LMH
Maximum 1 st year applied pressure	110 psig	7.6 bar
Maximum 1 st year feed pressure	130 psig	9.0 bar
Maximum 5 th year feed pressure	160 psig	11.0 bar
Maximum permeate back-pressure (total system)	20 psig	1.4 bar
1 st stage permeate rupture disc setting (design)	39 psig	2.7 bar

Table 2: Design Biscayne Raw Water Feed Quality and Permeate Quality Targets

Parameter	Unit	Raw Water	Permeate
Alkalinity (as CaCO ₃) (before acidification)	Mg/L	269	> 15
Hardness (as CaCO ₃)	Mg/L	270	< 30
Iron	Mg/L	2.0	< 0.15
Manganese	Mg/L	0.01	< 0.005
Color	SCU	90	< 3
TOC	Mg/L	11	< 1.0
TDS (as sum of the ions at initial operation)	Mg/L	500	
Temperature range	C	21-25	
pH (unacidified)	SU	7.0-7.3	
SDI (maximum per specification)	15-min	< 5.0	
Turbidity (maximum per specification)	NTU	< 1.0	
Sand Content (before strainer)	Mg/L		
H ₂ S	Mg/L	< 0.1	
Calcium (as CaCO ₃)	Mg/L	240	
Magnesium (as CaCO ₃)	Mg/L	30	
Strontium	Mg/L	< 0.4	
Barium	Mg/L	< 0.03	
Sodium	Mg/L	35	
Chloride	Mg/L	50	
Sulfate (before acidification)	Mg/L	32	
Flouride	Mg/L	0.2	
Bromide	Mg/L	0.1	
Silica	Mg/L	8.4	

Membrane Element Manufacturer Responsibilities

The MEM (Membrane Element Manufacturer) was selected based on the submittal of the lowest Present Worth Price. The Present Worth Price was based on the Total Lump Sum Capital Price plus the selected Operating Costs of estimated energy, acid and membrane replacement for a period of ten years.

The MEM was responsible for the supply of the following on-site man-power commitment:

- Supervision and certification of delivery and unloading
- Proper long-term storage assistance
- Installation of elements assistance
- Element performance testing assistance
- 5 days of training after successful startup to review proper installation, trouble-shooting, cleaning and maintenance of the membrane elements
- 20 days of technical and support service over and above the number of days included above.

The MEM was responsible for a guaranteed minimum 1st stage feed pH based on the raw water quality and maximum recovery during the warranty period. This pH could not be less than 6.6 to 6.8 with a design raw water pH of 7.0. The basis to estimating sulfuric acid cost in 2004 for ten years was a base cost of \$0.04 per pound of 100% sulfuric acid inflated 2% annually for ten

years with an interest rate of 6% per year. It is interesting to note that no one could have predicted the dramatic 350% increase in sulfuric acid cost from \$0.04 per pound of 100% sulfuric acid to \$0.17 to \$0.18 per pound in December, 2008 by large volume users in Florida municipal water plants. ⁽²⁾

Membrane Proof Test

The MEM was also responsible for conducting a 1,000 hour proof test of the membrane elements to be supplied for the 53 x 24-7M full-scale skid design. A proof test of membrane performance for the Peele-Dixie Membrane Plant was conducted during the period of September 2004 through November 2004 for a total of 1,031 hours of operation. The performance of the proof test met all requirements established in the contract documents which included the applied feed pressure and permeate water quality requirements. A scale inhibitor was used during the proof test with a dosing rate of 3.6 to 4.0 mg/l per the manufacturer recommendations. The maximum applied pressure was calculated as the difference in pressure between the membrane feed stream (measured at the feed manifold of each stage) and the permeate stream pressure (measured at the discharge of the stage permeate manifold).

Pilot testing for this project started in July 2004 at Well 27 of the new well-field. This was the chosen spot as this was the only new well that was drilled and developed at the "Notice to Proceed". All parties involved would have liked to have more of a composite well sample but that was not possible at the time. The pilot unit's configuration was a 2 x2 x1 x 1 array of 4-stages and 4-long membrane element vessels that hydraulically simulated a true 2 x 1 array with a 7M long membrane element vessel system. Piloting started with all ultra-low pressure RO membranes. The rejection performance was excellent, but the bicarbonate rejection was too good with not enough bicarbonate alkalinity ion passage to meet the engineers' requirements. Needing more bicarbonate salt passage, the installation of a lower rejecting ultra-low pressure RO membrane in the 2nd stage was performed and again permeate bicarbonate levels was still too low.

The final trial utilized a high-flow/low-rejection NF membrane in the last 3 positions of the 2nd stage. There were no changes in the lead 4 positions of this 2nd stage where the original RO membranes were used. This combination of RO and NF membranes in the 2nd stage resulted in a proper overall permeate quality that the engineers and the City were looking for. This Double Hybrid RO/NF system proved to be the winning strategy for achieving the higher ion passage for alkalinity while still passing sufficiently low levels of hardness, iron, TOC and color.

After approval by the engineers, commencement of the official 1000 hour Proof Test started and took approximately 42 days around the clock. Stream samples of raw, pretreated feed, 1st stage permeate, 2nd stage permeate, combined permeate, and 2nd stage concentrate were taken and analyzed for chosen ions by a NELAC certified laboratory. This Proof test was successful in that the Double Hybrid RO/NF membrane configuration allowed the proper passage of bicarbonate alkalinity, hardness, iron, TOC and color into the permeate for the given well water and for the amounts specified by the engineers at a low energy requirement and low feed pressures.

Graph 1: Normalized Applied Pressure for Proof Test

Normalized Applied Pressure
(23 degC, 15.1 GFD 1st Stage Flux, 11.2 GFD 2nd Stage Flux)

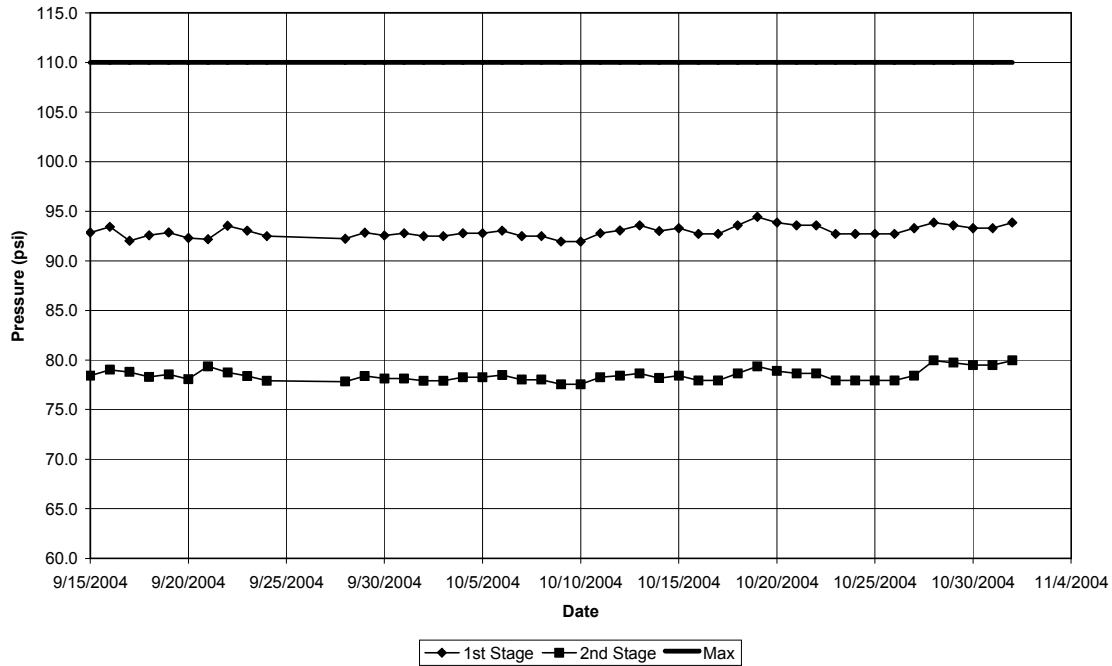

Graph 2: Normalized Permeate Alkalinity for Proof Test

Normalized Permeate Alkalinity - mg/l CaCO3
(23 degC, 85% Recovery, 13.9 GFD, 220 mg/l CaCO3 feed)

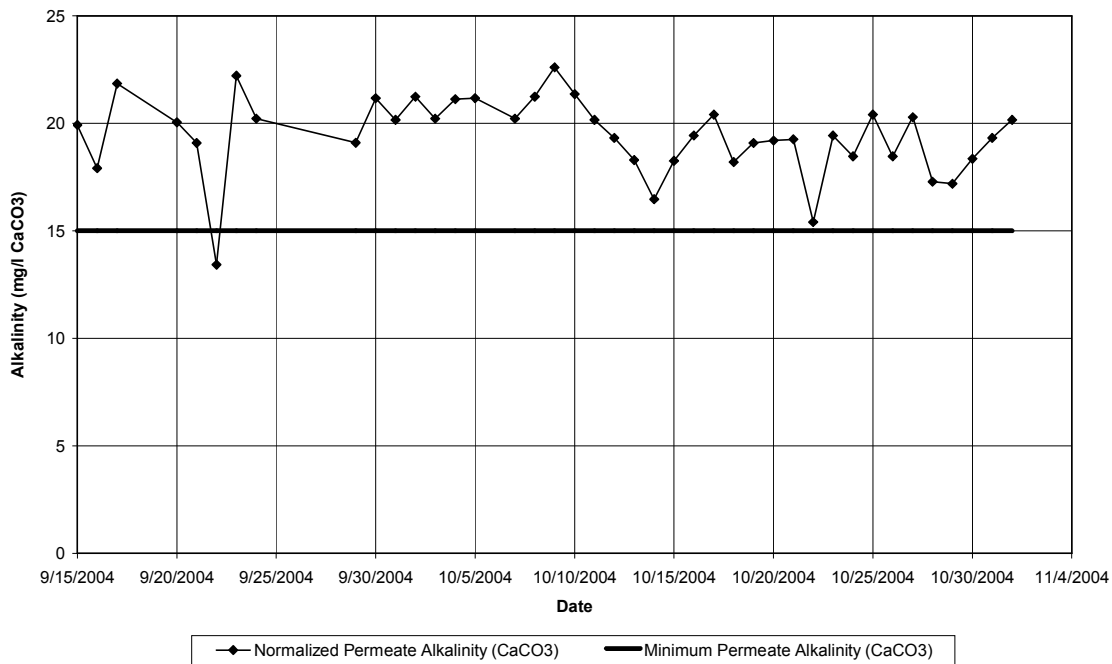

Graph 3: Normalized Permeate Iron for Proof Test

Normalized Permeate Iron - mg/l ion
(23 degC, 85% Recovery, 13.9 GFD, 2.0 mg/l iron feed)

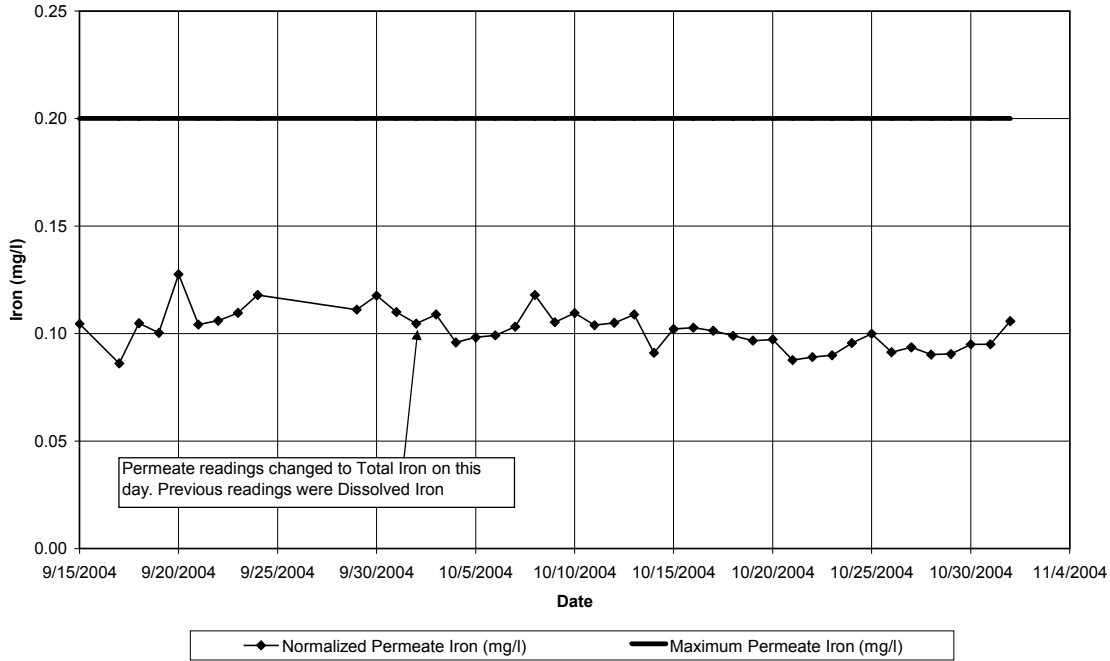

Graph 4: Normalized Permeate Total Hardness for Proof Test

Normalized Permeate Total Hardness - mg/l CaCO3
(23 degC, 85% Recovery, 13.9 GFD, 270 TH mg/l CaCO3 feed)

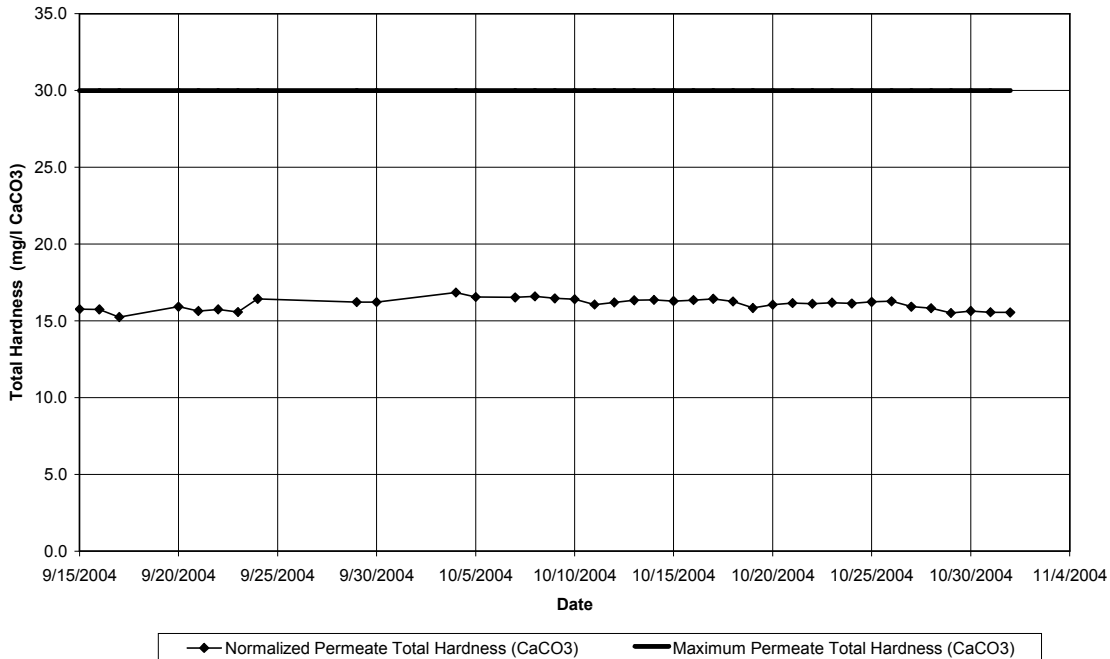

The specifications state that the permeate color shall be less than 3.0 CU (Color Units). Actual permeate color for both stages and the total permeate streams are reported < 1.0 CU (color units). The results of the bi-weekly color sampling are given in Table 3.

Table 3: Feed and Permeate Color for Proof Test

Constituent	Location	9/17/04	9/30/04	10/14/04	10/28/04
Apparent Color (pcu)	Raw	50	50	60	30
	Pretreated Feed	50	40	40	30
	Stage 1 Permeate	< 1.0	< 1.0	< 1.0	< 1.0
	Interstage	120	70	120	80
	Stage 2 Permeate	< 1.0	< 1.0	< 1.0	< 1.0
	Concentrate	120	350	300	140
	Total Permeate	< 1.0	< 1.0	< 1.0	< 1.0
	True Color (pcu)	Raw	50	50	60
Pretreated Feed		50	40	40	30
Stage 1 Permeate		< 1.0	< 1.0	< 1.0	< 1.0
Interstage		120	70	120	80
Stage 2 Permeate		< 1.0	< 1.0	< 1.0	< 1.0
Concentrate		120	350	300	140
Total Permeate		< 1.0	< 1.0	< 1.0	< 1.0

The specification states that the permeate TOC (total organic carbon) shall be less than 1.0 mg/l. The results of the bi-weekly TOC testing are summarized in Table 4.

Table 4: Feed and Permeate TOC for Proof Test

Constituent	Location	9/17/04	9/30/04	10/14/04	10/28/04
TOC (mg/l as C)	Raw	11	14	16	11
	Pretreated Feed	11	11	13	12
	Concentrate	61	66	69	62
	Total Permeate	< 0.5	0.7	2.2	< 0.5

Excluding the Oct 14th sample and using the limit of detection as the actual result, the average permeate TOC for the three other sample dates is less than 0.56 mg/l. Even including the erroneous data point, the average permeate TOC is less than 1.0 mg/l.

The specification stated that the proof test was to be used to determine cleaning procedures and an estimated cleaning frequency. Fortunately, there was not any significant fouling during the proof test, but this precluded the determination of cleaning solution types, protocol and frequency determination.

Construction and Startup of the Plant

The Peele-Dixie Membrane Treatment Plant was built on the property of the existing lime-softening facility with 32 wells tapped into the Biscayne aquifer. Low-pressure wells, with a history of yielding good production, were always sufficient for the lime plant. As construction was underway and new raw water mains were installed to the membrane plant, the need to flush and test the control system and instrumentation resulted in pipe pressures on the 55 year old well-field components. Needless to say, the higher pressure RO feed pumps and higher water-main velocities caused several ruptures of the old transmission mains in various parts of the well-field. This slowed the construction process down and these water-main breaks caused soil, sand, limestone shells, and debris to breach the piping and work their way into the plant. The extent of the problem didn't surface until it was time for the contractor and OEM to run functional demonstration tests of the plant to flow water from the well-field, through pretreatment, cartridge filters, and into all the RO Trains prior to the loading of RO and NF membranes.

Sand was washed out of the cartridge filter housings several times as the velocities of a simulated running unit caused construction debris to make its way down to the pretreatment from all the main breaks in the well-field during the previous months.

Once the delays were conquered and the functional testing was completed in the Spring of 2008, RO and NF membrane loading was started into a substantially complete plant. The same loading scheme used in the pilot plant was used for the full-scale Double Hybrid RO and NF Membrane System. This required the installation of all RO membranes for all of first stage pressure vessels and the same model of RO membranes in the first four lead positions of the 2nd stage. The last three positions of the 2nd stage pressure vessels were loaded with the high-flow/low-rejection NF membrane.

After getting the preliminary approval from the general contractor, construction engineer, design engineer and the City to startup the first set of membranes in the first RO/NF train, there was another situation of more debris from sand, limestone, and shells getting caught in the pretreatment panel instrumentation and cartridge filters which shut the whole operation down before the official Performance Acceptance Testing could begin again. With the presence of orange colored staining on the end cap components, the insides of the membrane vessels, piping, and cartridge filters, it was evident that there was more iron than expected to be dealt with in the feed water during this stage of the startup.

Performance Acceptance Testing and Operation

After getting these bugs worked out, the official Performance Acceptance Testing (PAT) began in April 2008. Performance started up as projected and after a week of running more than one train, the increased velocity of the mains pushed more debris into the cartridge filters. A new issue also surfaced as indicated by a slow flux decline and an increasing feed pressure of approximately 10 to 15 psi that was uncharacteristic of the pilot proof test back in 2004. Upon further inspections, some pressure vessel end-caps were pulled and orange discoloration of the membrane faces and components pointed to iron fouling and possibly other issues.

Feed water was pretreated with pH adjustment with sulfuric acid and antiscalant/iron dispersant as the other pretreatment chemical. Due to the astronomical cost increase by 350% of sulfuric acid, the City tried to cut back on the sulfuric acid consumption and rely more on

antiscalant/dispersant. The feed pH was adjusted up from a pH of 6.2 to 6.8 by reducing the acid feed rate, but this had the unintended consequence over the course of a week of converting what had been non-fouling soluble iron turn into an insoluble iron foulant. There was a noticeable 12 to 14% increase in feed pressures from approximately 105 psi to 120 psi and a normalized flux decline of approximately 10% from decreasing the H₂SO₄ acid dosage and allowing the feed to rise to 6.8 pH. Next was the decision to lower the feed pH and increase the H₂SO₄ acid feed, which made the iron go back into solution so it would not be a foulant. Over the next several days, the feed pressures improved and returned to the original startup conditions and the normalized permeate flow for both stages returned back to baseline.

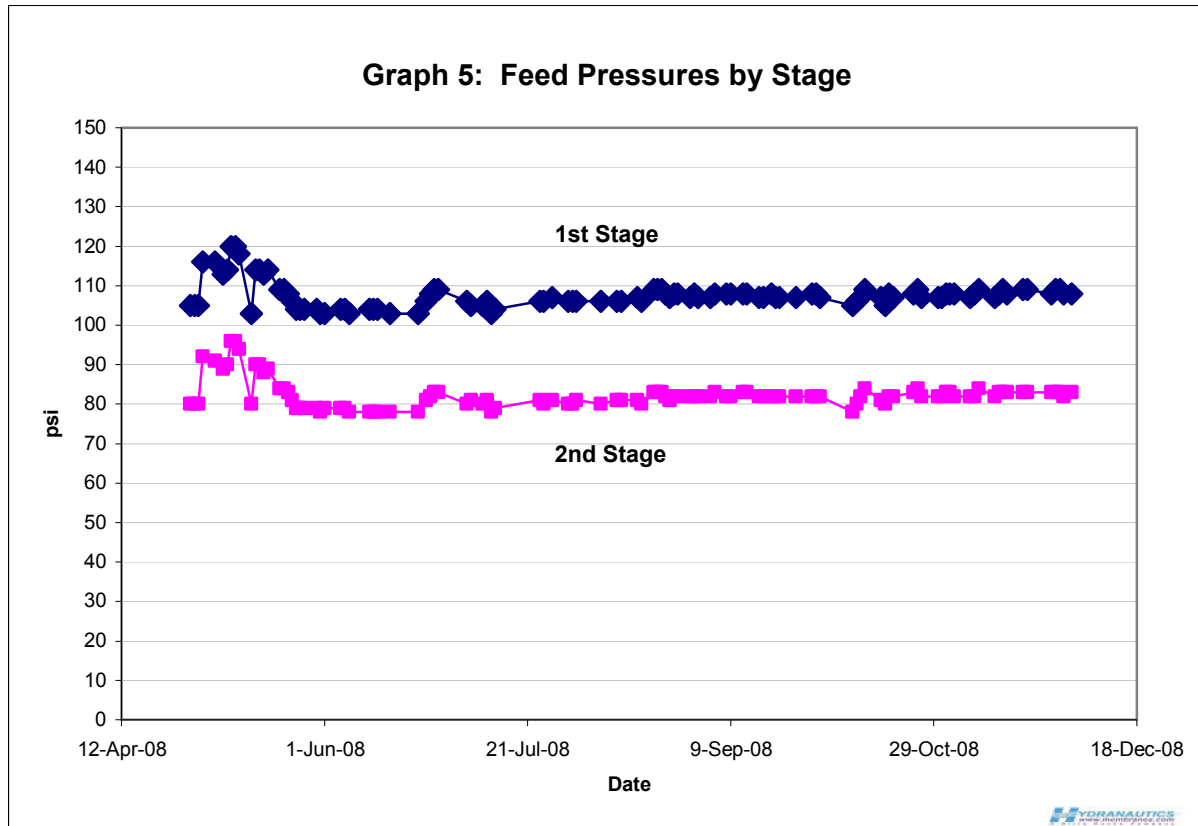

After several days of running at a feed pH of 6.2 and increasing the acid dosage, the decision was made to slowly decrease the acid dosage and increase the feed pH. The objective was to determine the optimal feed pH and antiscalant/dispersant dosage rate that would keep iron from precipitating out and still minimize acid usage to control operating costs.

The system is currently 10 months into operation and the performance on the membranes are still stable and consistent. The City has found a balance between a feed pH of 6.2 to 6.8 to control the rate of iron fouling. At startup, as seen in Graph 5: Feed Pressure by Stage, the feed pressure was approximately 105 psi and 10 months later the feed pressure was approximately 108 psi for the 1st stage. Graph 6 shows there was no apparent normalized permeate flow decline in either stage which indicated no fouling of the membrane surface. Graph 7 shows there was no normalized pressure drop increases between the feed and concentrate manifolds in either stage which indicated there was no fouling of the RO/NF feed path in either stage. Graph 8 shows there is no normalized % salt passage increase, as measured by conductivity,

for either stage which indicated that permeate quality meets the clients requirements and that there are no signs of fouling, particularly from iron foulant in the 2nd stage.

Normalized performance will be tracked on a weekly basis by the City and the normalized data reviewed at least monthly by the membrane supplier to ensure there are no issues with the membranes and the City can be given enough notice to take action as required. This plant, based on the normalized data, is evaluating the need for a cleaning after one year of operation. This cleaning would be more an issue of performing preventative routine maintenance, rather than by necessity. The advantages of an annual preventative maintenance cleaning will be discussed with the City at this time.

In conclusion, with the need by some water treatment plants like Ft. Lauderdale for the higher rejection of certain constituents (e.g. hardness, iron, TOC and color) and the higher passage of other ions (e.g. bicarbonate alkalinity), the use of a Double Hybrid RO/NF membrane system design is a creative and very feasible design to meet their goals. This unique design achieves the permeate quality the client required while still achieving maximum energy efficiency and electrical operating cost savings with lower feed pressures.

References:

- 1. Tampa Bay Water Agenda Item D5i, Gerald Seeber, Dec. 1, 2008
- 2. RO & NF Membrane Applications in the Southeastern USA; Cuozzo, Rocco; AMTA/SEDA 2008 Joint Conference & Exposition, Naples, FL. July, 2008.

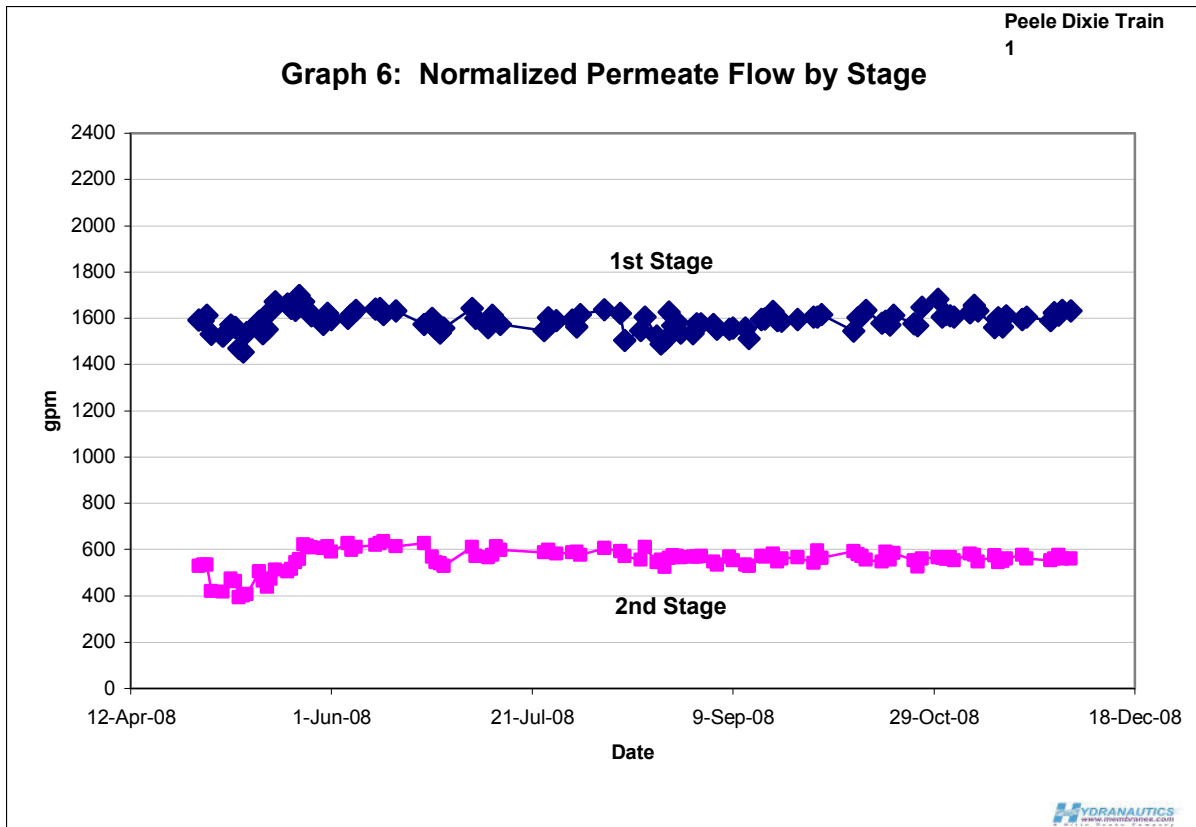

**Graph 7: Normalized Differential Pressure by Stage
(Feed to Concentrate)**

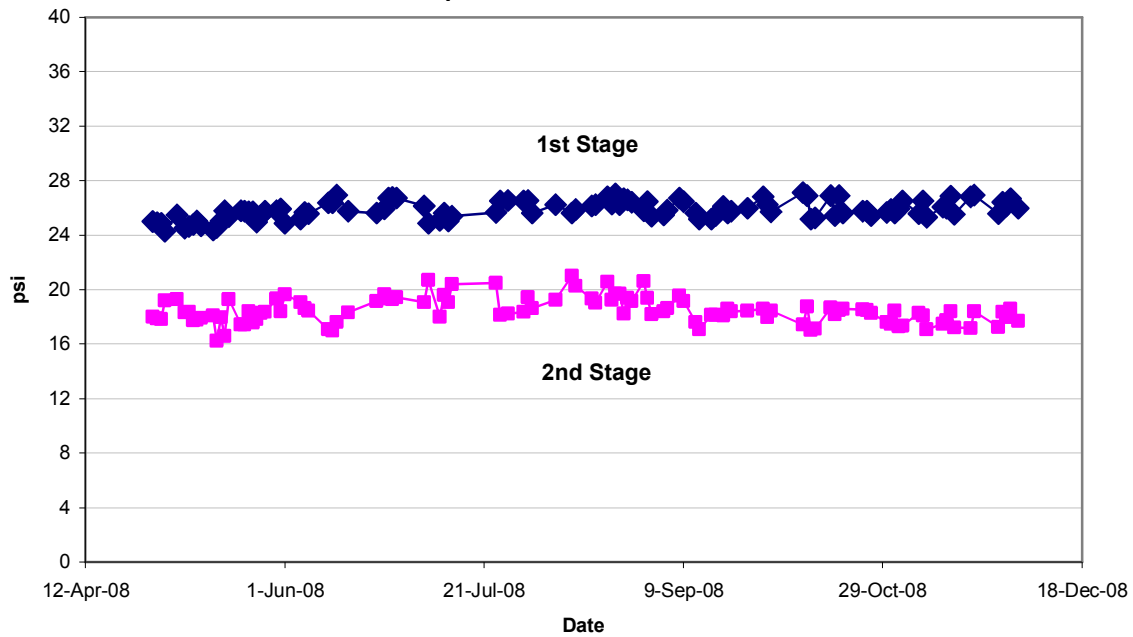

HYDRANAUTICS
www.creativewater.com
2008-2009-2010-2011

Peele Dixie Train

Graph 8: Normalized % Salt Passage by Stage

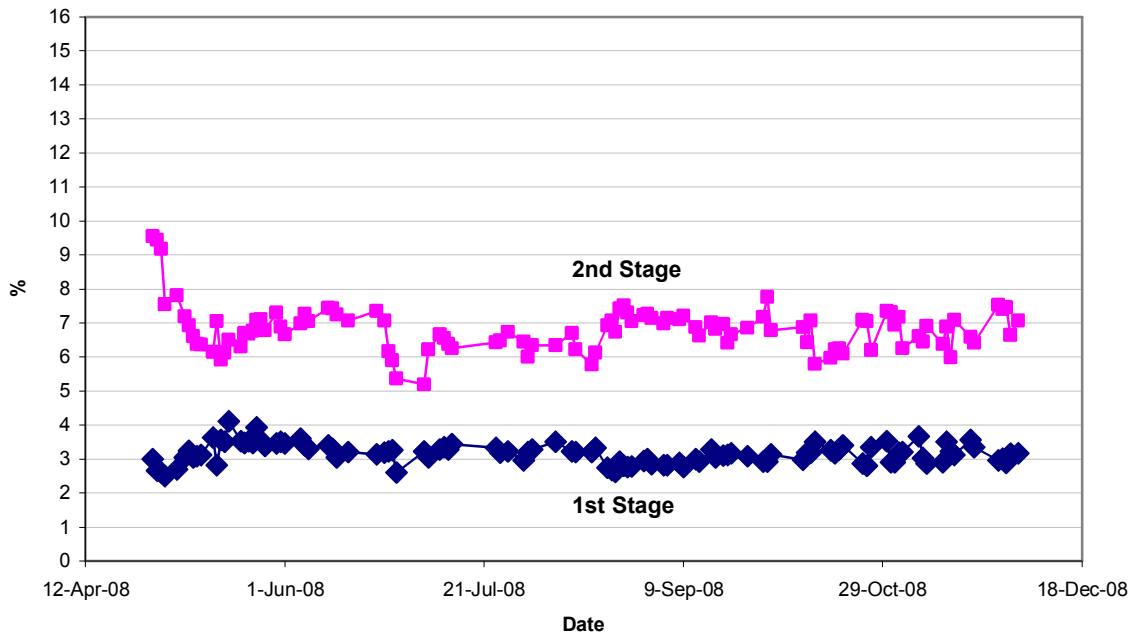

HYDRANAUTICS
www.creativewater.com
2008-2009-2010-2011