

Optimum RO System Design with High Area Spiral Wound Elements

Craig Bartels Ph. D, **Masahiko Hirose**, **Stefan Rybar** Ph. D and **Rich Franks**
Hydranautics – A Nitto Denko Company. Oceanside, CA

Abstract

The membrane and spiral wound elements used for seawater desalination continue to evolve, particularly in regards to lowering energy costs. Most recently, high area elements and ultra low pressure seawater reverse osmosis (SWRO) elements have come onto the market. Laboratory and pilot testing of these elements demonstrate that they can achieve both high rejection and low pressure operation. Use of these high performance SWRO products is a challenge, however. Detailed analysis indicates that the higher permeability membranes have a greater flux imbalance in the process, but there are ways to take advantage of these capabilities with proper system design. An example of the use of high area seawater membranes will be presented. It shows that significant capital savings can be achieved. Using high area elements to run at lower flux is also possible, but the economic gain is only realized when operating a one pass system.

Introduction

Advances in membrane technology continue to allow system designers more options for cost savings. These advances include higher rejection membranes, higher permeable membranes, and higher surface area elements. These new features, if used properly, can lower capital cost of the system or can result in lower energy consumption. It is important to understand the features of these new products so that they can be optimized and selected for the specific project needs.

One product feature for consideration is the higher surface area elements. Over the past 10 to 15 years, both brackish and seawater elements have been made with increased area. Brackish elements have increased from 365 ft² to 400 ft², and most recently to 430 or 440 ft². These changes have mostly been done by changing element construction, not by changing the membrane. A combination of new, thinner permeate spacers, optimized glue line placement, and material thickness control has led to the improvements. These same improvements are now being applied to seawater membranes as well. Seawater elements in the 1990's were typically around 310-325 ft², and then increased to 370 to 380 ft² in the mid to late 1990's. By late 1990's and early 2000's, most seawater elements contained 400 ft². Recently, 440 ft² seawater elements have been produced. These will become another means to further lower the cost of producing desalinated water.

For brackish water applications, the high area 440 ft² elements have found use in many applications, including well water treatment, membrane pretreated wastewater applications and for the second pass in seawater systems. Generally, these applications have a higher quality feedwater being supplied to the RO membranes. One example of this is the 147,000 m³/d wastewater treatment plant at Ulu Pandan in Singapore. This facility was designed with 13 trains in a 64 by 36 array of 440 ft² ESPA2+ elements. The system, which operates

at 18 lmh, has 10% less elements and pressure vessels because of the use of the high area elements. The plant has now been operating well for over a year with these elements.

Evolution of High Performance Seawater Elements

Improved seawater products have been developed in the past year to further reduce desalination costs. An example of the evolution of seawater products is shown in Table 1. It can be seen that the area of the element has increased from 320 ft² in the late 1980's to the new 440 ft² elements just announced. This represents a 38% increase in active area in the same 8 inch diameter by 40 inch element. Even if the membrane were not changed, this would represent a potential of 38% increase in water production from the same pressure vessel. However, there have also been improvements in the membrane chemistry. The latest, most advanced seawater elements can produce 12,000 gpd at 800 psi, compared to the 5000 gpd of the old 1980's technology. If you account for the area change, it can be seen that the membrane permeability has increased by 90%. Most importantly, this increase in water permeability has been achieved without a loss in rejection. In fact the rejection of elements has actually increased to meet the higher water quality demands of today.

Table 1 High Performance Seawater Product Evolution

Date	Type	Area		Flow		Rejection (%)
		(ft ²)	(m ²)	(gpd)	(m ³ /d)	
1987	SWC1	320	29.7	5000	19	99.5
2000	SWC3	370	34.4	5900	22.4	99.7
2006	SWC5	400	37.2	9000	34.2	99.8
2008	SWC5 Max	440	40.9	9900	37.6	99.8
2009	SWC6	400	37.2	12000	45.6	99.8

Test Conditions: Feed Pressure 55.2 bar (800 psi), Feed Salinity 32,000 mg/l NaCl, 25 C, 10% recovery

The most recent focus has been two-fold, one is the increase of area in the element, the other is the reduction of energy consumption. Utilizing the latest in materials, element design and manufacturing technology, it has been possible to build 440 ft² seawater elements. An example of a leaf from an SWC4+ Max, 440 ft² element is shown in Figure 1. The high active area of these new seawater elements has been achieved without changing the feed/brine spacer.

Laboratory testing of these elements is shown in Figure 2, where it can be seen that the SWC5 Max is achieving flow of about 9600 gpd and still has excellent rejection around 99.85%.

Figure 1 Example of Leaf from a SWC4+ Max Spiral Wound Element

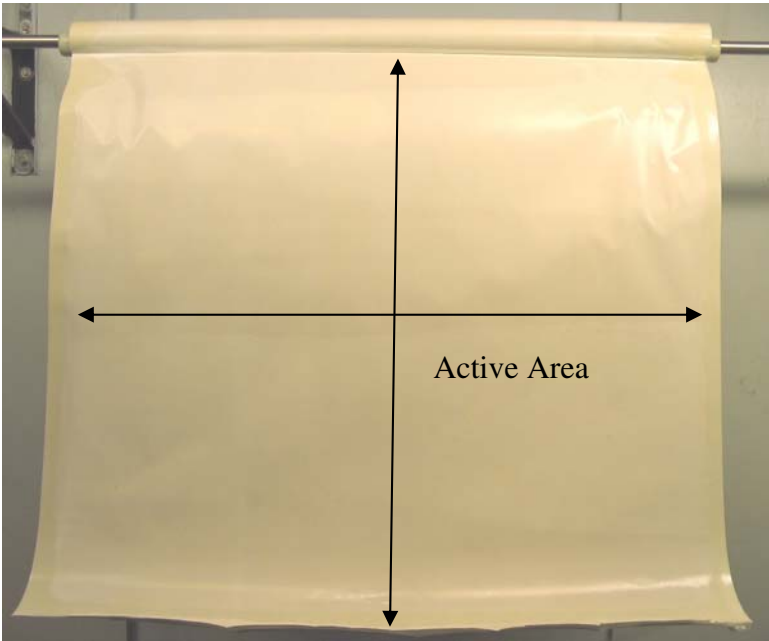

The second target of development is the reduction in energy consumption. New highly water permeable seawater membranes have been developed for this purpose. See Table 1 for an example, such as the SWC6 SWRO element. The laboratory testing of this new element is also shown in Figure 1. The SWC6 rejection has varied from 99.73 to 99.78% and flow from 11,500 to 12,300 gpd. This has demonstrated that it is feasible to achieve the high flow targets of 12,000 gpd and still maintain good rejection of 99.8% rej.

Figure 2 Laboratory testing of new seawater elements at standard test conditions

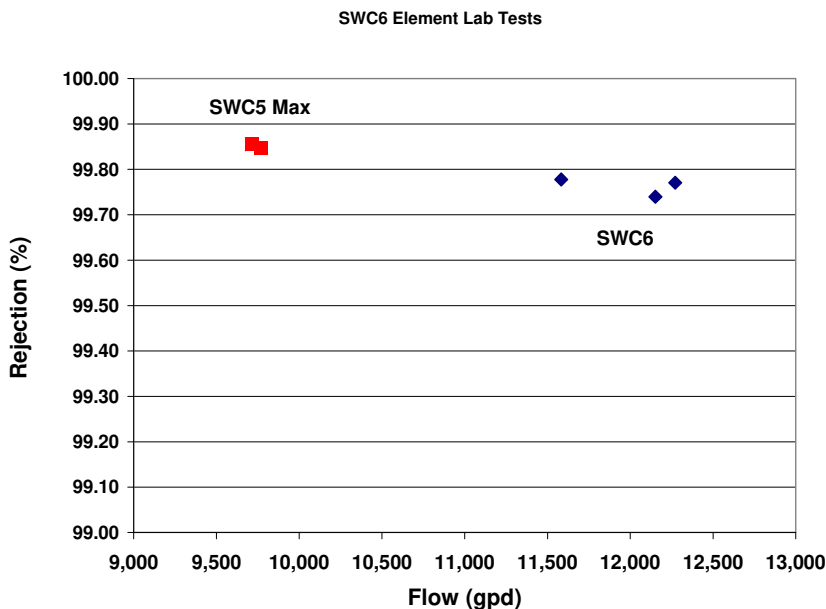

The new SWC6 has been tested at a pilot trial on the Pacific Ocean. The results of the testing are shown in Figure 3. The Water Transport Coefficient, or A Value shows that the water permeability is about 20% higher than the SWC5. However, with this higher

permeable membrane, there is some trade-off in terms of salt passage. It can be seen that the Salt Transport Coefficient, or B Value, of SWC6 is almost twice as high as that of SWC5.

Figure 3 Pilot testing results for new high flow SWRO elements

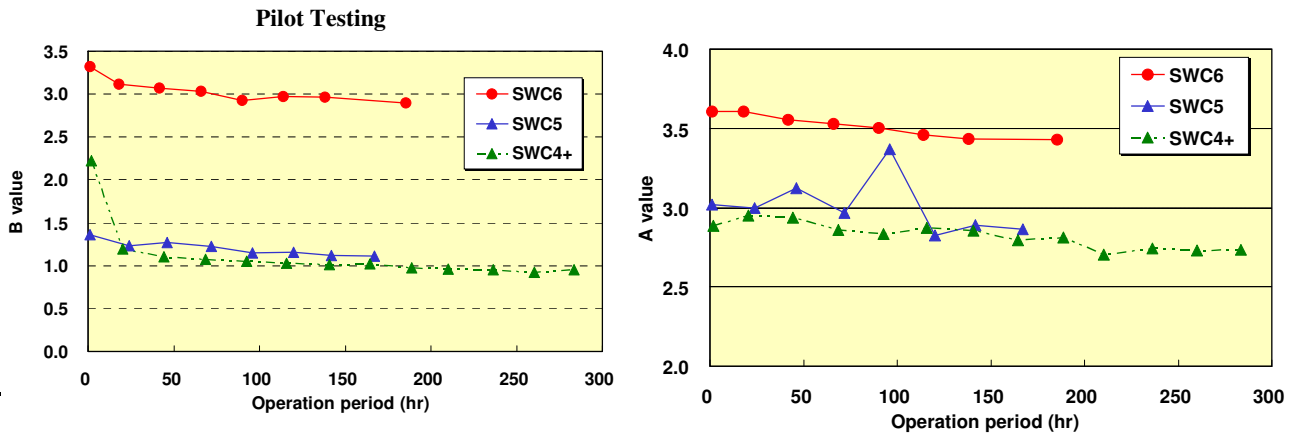

These developments lead to a very important issue – proper design of the RO process to take advantage of this new performance. The next sections of this paper will deal with this and explore the economic advantages that can be achieved.

Design Considerations

Use of the advanced seawater elements can result in lower operating and capital costs. [Wilf] As with brackish water plants, seawater plants can now take advantage of the higher area, 440 ft² elements. For example, 440 ft² seawater elements can be used to retrofit an existing system and increase output by 10% without additional infrastructure changes. Alternatively, the system can be operated at the same total flow rate, which means the actual flux rate is lowered. An example of the impact of the use of high area seawater elements is shown in Figure 3. This figure shows the permeate salinity, feed pressure and flux rate for a plant designed with standard 400 ft² elements and new 440 ft² elements. Table 2 lists the design conditions for this plant design.

Table 2 Design Conditions for Base Case

Feed Salinity	40,000	mg/l
Feed Temperature	25	C
Permeate Flow	440	m ³ /hr
Recovery	50	%
Array (vessels x elements)	120 x 7	
Flux	14.1	lmh

When a 400 ft² element is used, the flux is a typical 14.1 lmh. The required feed pressure is 63 bar and the permeate quality is 292 mg/l of TDS. In comparison the use of older technology 370 ft² element resulted in higher pressure, 67.2 bar, and higher salinity, 351 mg/l TDS. This design also used 10 more pressure vessels and 70 more elements.

In contrast, if the flux is to be maintained the same, the use of the new higher area 440 ft² elements can result in lower a lower number of pressure vessels, 109, compared to 120 for the base case. This results in the reduction of 77 less elements. Since the same

membrane is used in the 400 and 440 ft² elements, and the flux is the same, the permeate quality will be the same. (Figure 3).

Figure 4 Comparison of Performance advantages of standard and high area SWRO elements.

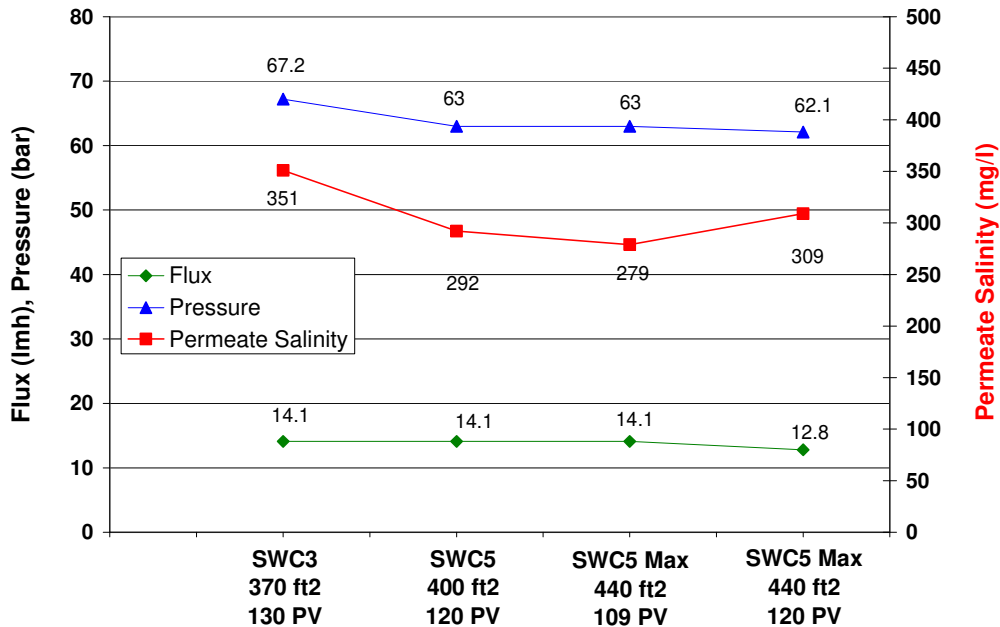

Alternatively, the same number of elements and pressure vessels can be used, which will lower flux from 14.1 lmh to 12.8 lmh. For this scenario, the reduced flux will result in lower pressure. Calculations show that this savings should be on the order of 1 bar reduction in pressure, which translates to approximately 1.5% savings in energy. As is often the case in RO applications, this benefit comes at the cost of poorer permeate quality. Operation at lower flux will result in 30 mg/l increase in permeate salinity. If this permeate salinity is acceptable, the lower pressure will result in substantial savings for a twenty year life cycle cost analysis.

In the case of retrofitting an existing plant, it may be desirable to increase water production from the same equipment. As long as the piping is adequately sized, it is possible to replace 400 ft² elements with 440 ft² elements and operate at the same flux. This will result in a 10% increase in water production.

Another question arises about how the higher area and higher productivity elements will impact flux balance in a SWRO process. Figure 4 shows the flux rates by element position for each of the designs used in Figure 3. The SWC3 membrane had the lowest water permeability, and it has the lowest flux differential of all the cases. The lead element to tail element flux ratio is 6.6 to 1. When membranes with higher permeability are used, this imbalance gets larger. This is unavoidable because the driving force will be less. Since recovery is unchanged, the driving force available for the last element will be less, since osmotic pressure in the tail element will be unchanged. For the standard 400 ft² element the flux ratio of lead to tail is nearly 12 to 1. This means that the feedwater quality should be the best possible to prevent colloidal and other common lead element fouling issues.

When the lower flux rate is used, the pressure is lower. This means that the NDP in the final element will be smaller. Again, since the recovery and tail element osmotic pressure remain unchanged, the flux imbalance will be even larger. In our case, the ratio of lead to tail elements was 14.2

If very high permeable membrane, such as SWC6, is used, this imbalance is even greater, 22 to 2. These issues will limit the ability of design engineers to gain much lower pressures. The higher permeable membrane thus are reaching a point of diminishing returns when used in a convention design. Future papers will consider the benefits of hybrid designs to capture the benefit of high permeable membranes.

Figure 5 Flux distribution in a SWRO vessel using various membrane element styles.

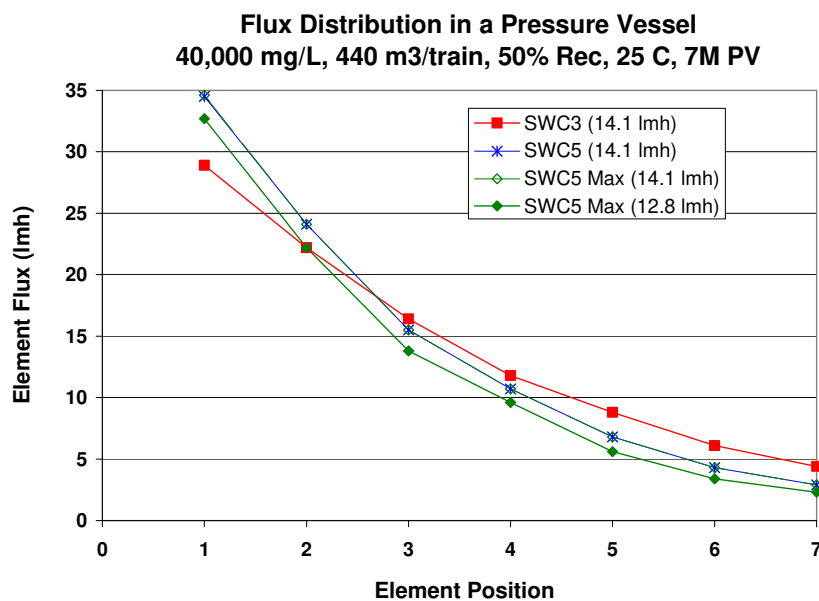

System Economics

A comparison of various designs was made for a two pass system which needed to achieve TDS less than 50 mg/l and boron less than 1.0 after 5 years. A split partial design was used as shown in Figure 6. Thus, a portion of the permeate from the front of the SWRO vessels was directed to the product tank, and the remainder of the permeate from the back of the vessel was directed to the second pass. The second pass permeate was then combined with the part of the untreated 1st pass permeate to form the product water.

Figure 6 Process flow diagram for a two pass RO design

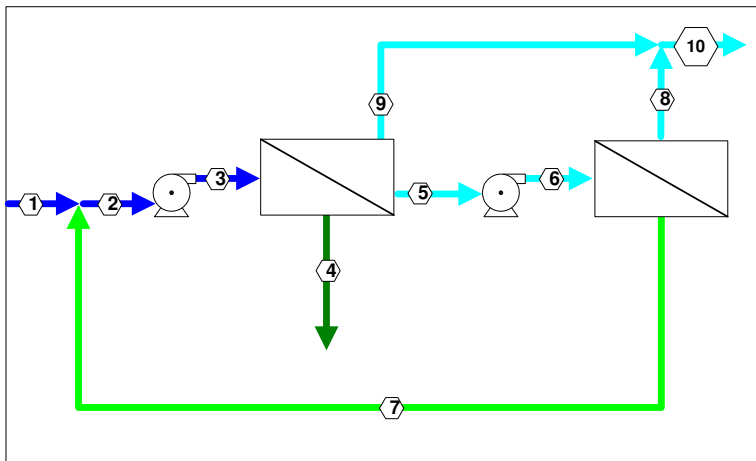

	1	2	3	4	5	6	7	8	9	10
Flow m3/hr	1476	1564	1564	860	586	586	88	498	118	616
Pressure bar	0.0	0.0	50.4	48.9	0.0	13.4	6.8	0.0	0.0	0.0
TDS (ppm)	34019	32241	32241	58402	297	297	2290	6.4	113	27

The capital and operating costs of the system were calculated using the assumptions given in Table 3. Designs at the minimum and maximum temperatures were evaluated to see the extreme points in the design and where the advantages were found.

Table 3 Assumptions used in the cost analysis

Seawater Design Assumptions

Prduct Flow (m3/d)	133,000	
No. Trains (1st/2nd)	9	9
Recovery (1st/2nd)	45%	85%
Feed Salinity	34019	mg/l
Temperature	16 to 28	deg C
Membrane Flux (lmh:1st/2nd)	12.7	31.0
Train Array (1st/2nd)	186x8M	36x12x8M
Energy Recovery	ERD	

Cost Assumptions

Membrane Cost (US\$ (1st/2nd))	500	460
Vessel Cost (US\$ (1st/2nd))	1200	1000
Electricity Cost (\$/kWhr)	0.08	
Membrane Life (yrs)	4.5	
Interest Rate(%)	6	
Depreciation (yrs)	20	

Three cases were considered as outlined in Table 4. The first case was the base case which employed the use of standard, high flow 400 ft² SWRO elements and 440 ft² brackish water (BWRO) elements. A second case was considered using high area, 440 ft² SWRO elements along with high area BWRO elements. In the design of Case 2, the number of vessels was reduced to keep the flux unchanged compared to Case 1. In Case 3, the high area SWRO element was again used, but this time the number of vessels was kept constant, which resulted in lower flux, and thus lower energy consumption.

Comparison of Case 1 and 2 at low temperature shows that there was a reduction of 17 pressure vessels and 108 elements per train. This results in an approximate savings of \$5 million in capital costs. Since the rejection and permeability of the two membranes is the same, the energy and chemical cost is the same.

Table 4 Cost analysis of a two pass SWRO facility with different high performance SWRO elements.

Case	Temp	Element Area	SWRO Press Vess/Array	SWRO Flux	SWRO Feed Press	RO Plant Capital Cost	OPEX	Energy Cost	Chemical Cost
	°C	ft ²		lmh	bar	US\$	US\$/yr	US\$/yr	US\$/yr
1a	16	400	186	12.7	51.7	64,804,144	29,672	12,136	1,223
1b	28	400	186	12.9	49.2	64,772,088	29,898	11,773	1,787
2a	16	440	169	12.7	51.9	60,106,156	29,073	12,199	1,223
2b	28	440	169	12.9	49.4	60,075,308	29,290	11,827	1,787
3a	16	440	186	11.6	50.4	65,441,524	29,814	11,994	1,252
3b	28	440	186	11.7	48.3	65,441,524	30,104	11,687	1,823

It can be seen in Table 4 that Case 2 has the lowest capital cost, saving almost \$5 million. This is a direct result of the reduced number of vessels and piping that would otherwise be required for the lower area 400 ft² SWRO elements. The operating expense (OPEX) was also slightly reduced because the amortized capital was slightly lower. Additional savings could be realized if the total number of trains was reduced 10%, for example, going from 9 trains to 8 trains. This would also result in a reduction in the number of valves, controls and other ancillary equipment. This type of savings is being realized on large plants, such as the Ulu Pandan Wastewater Treatment Plant, which used 440 ft² BWRO elements. [Franks] Figure 7 compares the key operational values of Case 2 as a ratio to Case 1. When this ratio is one, it means the two cases are equal.

In contrast, Table 4 shows that Case 3 has the same number of elements as Case 1, but lower flux. This results in lower operating cost. The number of elements and vessels was the same. The capital cost was slightly higher due to the higher price of the high area elements. A comparison shows that the SWRO feed pressure to the 440 ft² element is about 1 bar less than the SWRO feed pressure for the 400 ft² element. This results in a substantial lowering of the SWRO energy consumption. However, operation at lower flux has resulted in higher salt passage (less dilution of the permeate). To accommodate for this, the amount of water treated in the second pass had to be larger and the pH in the second pass of the 440 SWRO design also needed to be slightly higher. This means that the energy consumption of the second pass was larger and the chemical consumption in the second pass was slightly greater. The net result was that Case 3 had no net savings, rather, it cost slightly more to operate, and it had slightly higher capital cost. (Figure 4)

Thus, operation at lower flux would only be beneficial in the case of a one pass design, where permeate quality could still be met at the lower flux. No additional second pass treatment would be needed, so the outright savings of operating at lower flux can be realized.

Figure 7 Relative advantages and disadvantages of new SWRO element designs.

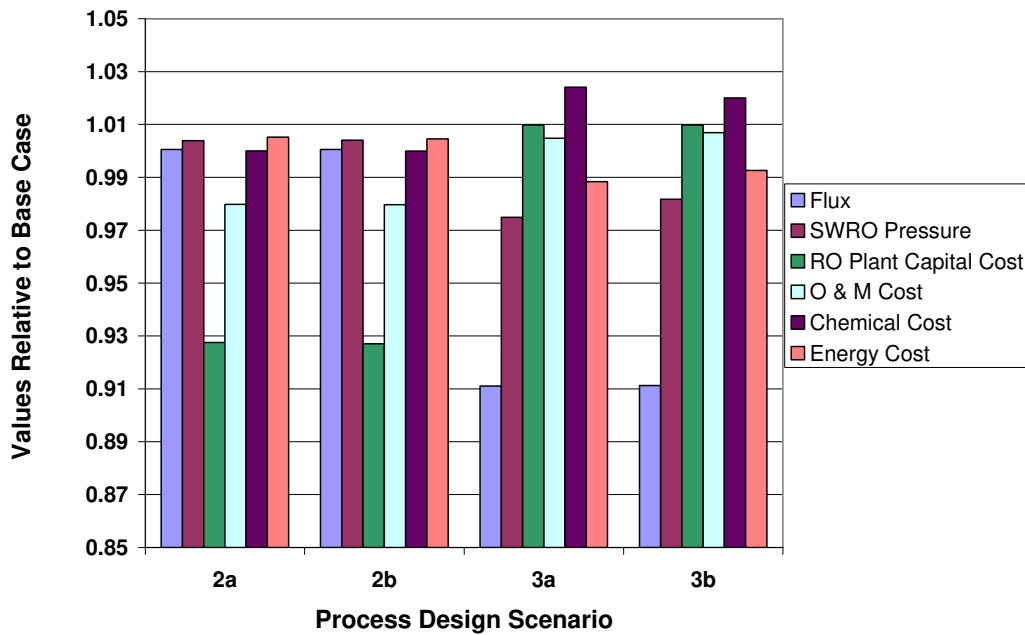

Conclusions

In conclusion it has been shown that new high performance elements can be made and will have a profound impact on the system designs in the future. Two recent developments are the high area, 440 ft² elements, and the new high flow SWRO element. Both have been manufactured with the state of the art membrane chemistry and the latest in element manufacturing technology. These have been tested in the lab and in pilot tests.

Analysis of designs which take advantage of these new properties was considered. The high area, 440 ft² elements can reduce the capital cost of the system by reducing the number of pressure vessels and related piping. They also can reduce the size of the RO building. Alternatively, they can be used to reduce the feed pressure to the SWRO trains by running at lower flux rates. This results in as much as 1 bar of pressure savings, with minimal additional capital expense. The benefit of the latter design is only apparent if the design is for a one pass system. The poorer permeate quality resulting from operation at lower flux will require that the second pass is larger. In this case, the benefit of the lower 1st pressure is negated by increased 2nd pass production.

Both new elements can result in significant savings, however, the designer needs to carefully consider the RO design to take advantage of these new products. In optimum cases, the savings can be very substantial.

References

1. Wilf and Bartels, "Optimization of seawater RO systems design", *Desalination* 173 (2005) 1-12.
2. Franks, Bartels, Andes and Patel, "Implementing Energy Saving RO Technology in Large Scale Wastewater Treatment Plants", *World Congress on Desalination and Water Reuse, IDA Conference, Maspalomas, Gran Canaria, Spain, 2007.*